

Gripper

RADIAL MOTION Double Acting



B-4S

B

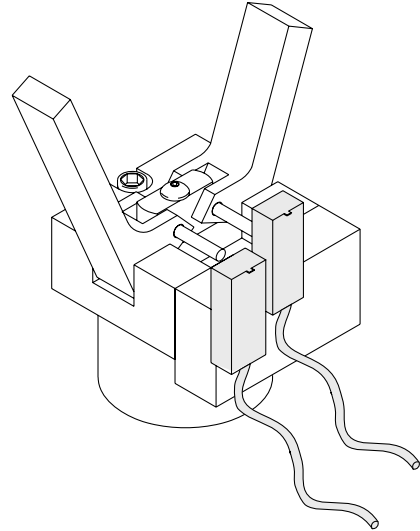

Proximity sensors
preassembled for
open & closed positions
(see page 54)

TECHNICAL DATA:

Weight	5.5 lbs
Max Rec. Load	30 lbs
Force @ 80 psi	88 lbs @ F
Operating Pressure	60-100 PSI

